

|           |   |    |
|-----------|---|----|
| <b>DE</b> | Gebrauchsanleitung / Montageanleitung               | 2  |
| <b>FR</b> | Mode d'emploi / Instructions de montage             | 2  |
| <b>EN</b> | Instructions for use / assembly instructions        | 3  |
| <b>IT</b> | Istruzioni per l'uso / Istruzioni per Installazione | 3  |
| <b>ES</b> | Modo de empleo / Instrucciones de montaje           | 4  |
| <b>NL</b> | Gebruiksaanwijzing / Handleiding                    | 4  |
| <b>DK</b> | Brugsanvisning / Monteringsvejledning               | 5  |
| <b>PT</b> | Instruções para uso / Manual de Instalação          | 5  |
| <b>PL</b> | Instrukcja obsługi / Instrukcja montażu             | 6  |
| <b>CS</b> | Návod k použití / Montážní návod                    | 6  |
| <b>SK</b> | Návod na použitie / Montážny návod                  | 7  |
| <b>ZH</b> | 用户手册 / 组装说明   | 7  |
| <b>RU</b> | Руководство пользователя /<br>Инструкция по монтажу | 8  |
| <b>FI</b> | Käyttöohje / Asennusohje                            | 8  |
| <b>SV</b> | Bruksanvisning / Monteringsanvisning                | 9  |
| <b>LT</b> | Vartotojo instrukcija / Montavimo instrukcijos      | 9  |
| <b>TR</b> | Kullanım kılavuzu / Montaj kılavuzu                 | 10 |
| <b>HR</b> | Upute za uporabu / Uputstva za instalaciju          | 11 |
| <b>RO</b> | Manual de utilizare / Instrucțiuni de montare       | 11 |
| <b>EL</b> | Οδηγίες χρήσης / Οδηγία συναρμολόγησης              | 12 |
| <b>SL</b> | Navodilo za uporabo / Navodila za montažo           | 12 |
| <b>ET</b> | Kasutusjuhend / Paigaldusjuhend                     | 13 |
| <b>LV</b> | Lietošanas pamācība / Montāžas instrukcija          | 13 |
| <b>SR</b> | Uputstvo za upotrebu / Uputstvo za montažu          | 14 |
| <b>NO</b> | Bruksanvisning / Montasjeveiledning                 | 14 |
| <b>BG</b> | Инструкция за употреба /<br>Ръководство за монтаж   | 15 |
| <b>SQ</b> | Udhëzuesi i përdorimit / Udhëzime rreth montimit    | 15 |
| <b>AR</b> | دليل الاستخدام / تعليمات التجميع                    | 16 |
| <b>HU</b> | Használati útmutató / Szerelési útmutató            | 16 |
| <b>JP</b> | 取扱説明書 / 施工説明書                                       | 17 |

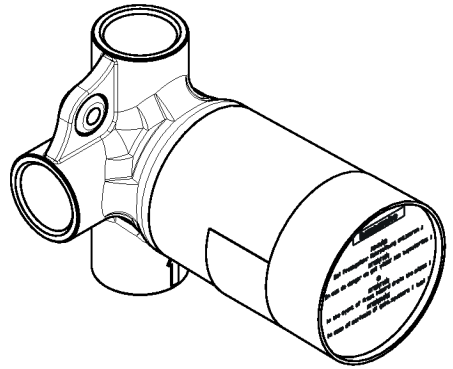

**Trio Stop**  
15981180 / 15981187



## Sicherheitshinweise

- △ Bei der Montage müssen zur Vermeidung von Quetsch- und Schnittverletzungen Handschuhe getragen werden.
- △ Große Druckunterschiede zwischen den Kalt- und Warmwasseranschlüssen müssen ausgeglichen werden.

## Montagehinweise

- Vor der Montage muss das Produkt auf Transportschäden untersucht werden. Nach dem Einbau werden keine Transport- oder Oberflächenschäden anerkannt.
- Die Leitungen und die Armatur müssen nach den gültigen Normen montiert, gespült und geprüft werden.
- Die in den Ländern jeweils gültigen Installationsrichtlinien sind einzuhalten.
- Die Armatur muss isoliert und schallentkoppelt montiert werden.

Geräuschklasse II wird bis zu einer Durchflussleitung von 30 l/min erreicht.

## Symbolerklärung



Kein essigsäurehaltiges Silikon verwenden!



**Maße** (siehe Seite 18)



**Serviceteile** (siehe Seite 20)

## Sonderzubehör

(nicht im Lieferumfang enthalten)



Verlängerung 25 mm #96370000  
(siehe Seite 20)



**Fertigset** (siehe Seite 20)



**Montagebeispiele** (siehe Seite 19)



## Consignes de sécurité

- △ Lors du montage, porter des gants de protection pour éviter toute blessure par écrasement ou coupure.
- △ Il est conseillé d'équilibrer les pressions de l'eau chaude et froide.

## Instructions pour le montage

- Avant son montage, s'assurer que le produit n'a subi aucun dommage pendant le transport. Après le montage, tout dommage de transport ou de surface ne pourra pas être reconnu.
- Les conduites et la robinetterie doivent être montés, rincés et contrôlés selon les normes en vigueur.
- Les directives d'installation en vigueur dans le pays concerné doivent être respectées.
- La robinetterie doit être montée de façon isolée et insonorisée.

Classification acoustique II est atteinte jusqu'à un débit de 30 l/min.

## Description du symbole



Ne pas utiliser de silicone contenant de l'acide acétique!



**Dimensions** (voir pages 18)



**Pièces détachées** (voir pages 20)

## Accessoires en option

(ne fait pas partie de la fourniture)



jeu de rallonge 25 mm  
#96370000 (voir pages 20)



**Set de finition** (voir pages 20)



**Exemples de montage**  
(voir pages 19)

## Montage

(siehe Seite 18) 

## Montage

(voir pages 18) 

** Safety Notes**

- △ Gloves should be worn during installation to prevent crushing and cutting injuries.
- △ The hot and cold supplies must be of equal pressures.

**Installation Instructions**

- Prior to installation, inspect the product for transport damages. After it has been installed, no transport or surface damage will be honoured.
- The pipes and the fixture must be installed, flushed and tested as per the applicable standards.
- The plumbing codes applicable in the respective countries must be observed.
- The fittings must be mounted in an insulated manner and with sound insulation.

**Symbol description**

Do not use silicone containing acetic acid!



**Dimensions** (see page 18)



**Spare parts** (see page 20)

**Special accessories** (order as an extra)



extension 25 mm #96370000 (see page 20)



**Finish set** (see page 20)



**Installation example** (see page 19)

** Indicazioni sulla sicurezza**

- △ Durante il montaggio, per evitare ferite da schiacciamento e da taglio bisogna indossare guanti protettivi.
- △ Attenzione! Compensare le differenze di pressione tra i collegamenti dell'acqua fredda e dell'acqua calda.

**Istruzioni per il montaggio**

- Prima del montaggio è necessario controllare che non ci siano stati danni durante il trasporto. Una volta eseguito il montaggio, non verranno riconosciuti eventuali danni di trasporto o delle superfici.
- Montare, lavare e controllare tubature e rubinetteria rispettando le norme correnti.
- Vanno rispettate le direttive di installazione nazionali vigenti nel rispettivo paese.
- Il rubinetto deve essere installato isolato e disaccoppiato dai rumori.

L'inserimento in Classe di rumore II è garantito fino a una portata di 30 l / min.

**Descrizione simbolo**

Non utilizzare silicone contenente acido acetico!



**Ingombri** (vedi pagg. 18)



**Parti di ricambio** (vedi pagg. 20)

**Accessori speciali**

(non contenuto nel volume di fornitura)



Prolunga 25 mm #96370000 (vedi pagg. 20)



**Set esterno** (vedi pagg. 20)



**Esempio di installazione**  
(vedi pagg. 19)

**Assembly**

(see page 18) 

**Montaggio**

(vedi pagg. 18) 



## Indicaciones de seguridad

- △ Durante el montaje deben utilizarse guantes para evitar heridas por aplastamiento o corte.
- △ Grandes diferencias de presión en servicio entre agua fría y agua caliente deben equilibrarse.

## Indicaciones para el montaje

- Antes del montaje se debe examinar el producto contra daños de transporte. Después de la instalación no se reconoce ningún daño de transporte o de superficie.
- Los conductos y la grifería deben montarse, lavarse y comprobarse según las normas vigentes.
- Es obligatorio el cumplimiento de las directrices de instalación vigentes en el país respectivo.
- El grifo debe ser instalado con aislamiento y desacoplamiento acústico.

## Descripción de símbolos



No utilizar silicona que contiene ácido acético!



**Dimensiones** (ver página 18)



**Repuestos** (ver página 20)

**Opcional** (no incluido en el suministro)



Prolongación 25 mm  
#96370000 (ver página 20)



**Embellecedor exterior**  
(ver página 20)



**Ejemplos de montaje** (ver página 19)



## Veiligheidsinstructies

- △ Bij de montage moeten ter voorkoming van knel- en snijwonden handschoenen worden gedragen.
- △ Grote drukverschillen tussen de koud- en warmwater-toevoer dienen vermeden te worden.

## Montage-instructies

- Vóór de montage moet het product gecontroleerd worden op transportschade. Na de inbouw wordt geen transport- of oppervlakteschade meer aanvaard.
- De leidingen en armaturen moeten gemonteerd, gespoeld en gecontroleerd worden volgens de geldige normen.
- De in de overeenkomstige landen geldende installatierichtlijnen moeten nageleefd worden.
- De armatuur moet geïsoleerd en geluidsontkoppeld gemonteerd worden.

## Symboolbeschrijving



Gebruik geen zuurhoudende siliconen!



**Maten** (zie blz. 18)



**Service onderdelen** (zie blz. 20)

## Toebehoren

(behoort niet tot het leveringspakket)



Verlengstuk 25 mm #96370000 (zie blz. 20)



**Kleurset** (zie blz. 20)



**Montagevoorbeelden** (zie blz. 19)

## Montaje

(ver página 18)

## Montage

(zie blz. 18)



## Sikkerhedsanvisninger

- △ Ved monteringen skal der bruges handsker for at undgå kvæstelser og snitsår.
- △ Større trykforskelle mellem koldt og varmt vand bør udjævnes.

## Monteringsanvisninger

- Før monteringen skal produktet kontrolleres for transportskader. Efter monteringen godkendes transportskader eller skader på overfladen ikke længere.
- Ledningerne og armaturerne skal monteres, skylles og kontrolleres iht. de gældende standarder.
- Installationsbestemmelserne, der gælder i det enkelte land, skal overholdes.
- Armaturet skal monteres isoleret og lydisoleret.

## Symbolbeskrivelse

 Der må ikke benyttes eddikesyreholdig silikone!

 **Målene** (se s. 18)

 **Reservedele** (se s. 20)

**Specialtilbehør** (ikke med i leveringsomfang)

 Forlængersæt 25 mm #96370000 (se s. 20)

 **Kappesæt** (se s. 20)

 **Monteringseksempler** (se s. 19)

## Avisos de segurança

- △ Durante a montagem devem ser utilizadas luvas de protecção, de modo a evitar ferimentos resultantes de entalamentos e de cortes.
- △ Grandes diferenças entre as pressões das águas quente e fria devem ser compensadas.

## Avisos de montagem

- Antes da montagem deve-se controlar o produto relativamente a danos de transporte. Após a montagem não são aceites quaisquer danos de transporte ou de superfície.
- As tubagens e a torneira têm que ser montadas, enxaguadas e verificadas de acordo com as normas em vigor.
- A prescrições de instalação válidas nos respetivos países devem ser respeitadas.
- A torneira deve ser montada de forma isolada e desacoplada sonoramente.

## Descrição do símbolo

 Não utilizar silicone que contenha ácido acético!

 **Medidas** (ver página 18)

 **Peças de substituição**  
(ver página 20)

## Acessórios especiais

(não incluído no volume de fornecimento)

 Crescente 25 mm #96370000 (ver página 20)

 **Conjunto completo** (ver página 20)

 **Exemplos de montagem**  
(ver página 19)

## Montering

(se s. 18) 

## Montagem

(ver página 18) 

**Wskazówki bezpieczeństwa**

- △ Aby uniknąć zranień na skutek zgniecenia lub przecięcia, podczas montażu należy nosić rękawice ochronne.
- △ Znaczne różnice ciśnień na doptywach ciepłej i zimnej wody muszą zostać wyrównane.

**Wskazówki montażowe**

- Przed montażem należy skontrolować produkt pod kątem szkód transportowych. Po montażu nie widać żadnych szkód transportowych ani szkód na powierzchni.
- Przewody i armatura muszą być montowane, płukane i kontrolowane według obowiązujących norm.
- Należy przestrzegać wytycznych instalacyjnych obowiązujących w danym kraju.
- Armaturę należy zaizolować i zamontować z izolacją dźwiękową.

**Opis symbolu**

Nie stosować silikonów zawierających kwas octowy!



**Wymiary** (patrz strona 18)



**Części serwisowe** (patrz strona 20)

**Wyposażenie specjalne**

(Nie jest częścią dostawy)



Przedłużka 25 mm  
#96370000 (patrz strona 20)



**Elementy zewnętrzne**  
(patrz strona 20)



**Przykłady montażowe**  
(patrz strona 19)

**Bezpečnostní pokyny**

- △ Pro zabránění řezným zraněním a pohmožděním je nutné při montáži nosit rukavice.
- △ Je nutné vyrovnat velké rozdíly tlaku mezi přípoji studené a teplé vody.

**Pokyny k montáži**

- Před montáží je třeba produkt zkontrolovat, zda nebyl při transportu poškozen. Po zabudování nebudou uznány žádné škody způsobené transportem nebo poškození povrchu.
- Vedení a armatura musí být namontovány, propláchnuty a otestovány podle platných norem.
- Je třeba dodržovat montážní pravidla platné v dané zemi.
- Při instalaci musí být provedena tak, aby byla baterie zaizolovaná a zvukotěsná.

**Popis symbolů**

Nepoužívat silikon s obsahem kyseliny octové!



**Rozměry** (viz strana 18)



**Servisní díly** (viz strana 20)

**Zvláštní příslušenství**

(není součástí dodávky)



prodloužení 25 mm #96370000 (viz strana 20)



**Vrchní sada** (viz strana 20)



**Příklady montáže** (viz strana 19)

**Montaż**

(patrz strona 18)

**Montáž**

(viz strana 18)

**⚠ Bezpečnostné pokyny**

- △ Pri montáži musíte nosiť rukavice, aby ste predišli pomliaždeninám a rezným poraneniam.
- △ Veľké rozdiely v tlaku medzi prípojkami studenej a teplej vody musia byť vyrovnané.

**Pokyny pre montáž**

- Pred montážou musíte produkt skontrolovať, či nebol počas transportu poškodený. Po zabudovaní nebudú uznané žiadne škody spôsobené transportom alebo poškodenia povrchu.
- Ledningarna och blandaren måste monteras, spolansigenom och kontrolleras enligt de gällande normerna.
- Je potrebné dodržiavať smernice o inštalácii, ktoré sú práve teraz platné v krajinách.
- Armatúra sa musí namontovať zaizolovaná a s oddelením od hluku v pevných telesách.

**Popis symbolov**

Nepoužívať silikón s obsahom kyseliny octovej!



**Rozmery** (viď strana 18)



**Servisné diely** (viď strana 20)

**Zvláštne príslušenstvo**

(nie je súčasťou dodávky)



Predĺženie 25 mm #96370000 (viď strana 20)



**Vrchná sada** (viď strana 20)



**Príklady montáže** (viď strana 19)

**⚠ 安全技巧**

- △ 装配时为避免挤压和切割受伤，必须戴上手套。
- △ 冷热水管间过大的压力差必须予以平衡。

**安装提示**

- 安装前必须检查产品是否受到运输损害。安装后将不认可运输损害或表面损伤。
- 管道和阀门必须根据通用标准进行安装、冲洗和检查。
- 请遵守当地国家现行的安装规定。
- 龙头必须以静噪的方式独立安装。

**符号说明**

请勿使用含有乙酸的硅胶！



大小 (参见第页 18)



备用零件 (参见第页 20)

**选装附件 (不在供货范围内)**

加长 25 mm #96370000 (参见第页 20)



加工件 (参见第页 20)



安装示意 (参见第页 19)

**Montáž**

(viď strana 18)

**安装**

(参见第页 18)



## Ук з ния по технике безоп сности

- △ Во время монтажа следует надеть перчатки во избежание прищемления и порезов.
- △ донного клапа. Перед установкой смесителя необходимо регулировочными кранами выровнять авление холодной и горячей воды при помощи вентмлей регулирующих подачу воды в квартиру.

## Ук з ния по монт жу

- Перед монтажом следует проверить изделие на предмет повреждений при перевозке. После монтажа претензии о возмещении ущерба за повреждения при перевозке или повреждения поверхностей не принимаются.
- Трубы и арматура должны быть установлены, промыты и проверены в соответствии с действующими нормами.
- Необходимо соблюдать требования по монтажу, действующие в соответствующих странах.
- Арматура должна монтироваться изолированно и со звуковой защитой.

## Опис ние символов



Не применяйте силикон, содержащий уксусную кислоту.



**Р змеры** (см. стр. 18)



**Комплект** (см. стр. 20)

## Специ льные прин длежности

(не включено в объем поставки!)



Удлинение 25 мм #96370000 (см. стр. 20)



**Н ружн я ч сть** (см. стр. 20)



**в ринты уст новки** (см. стр. 19)



## Turvallisuusohjeet

- △ Asennuksessa on käytettävä käsineitä puristumien ja viiltojen aiheuttamien tapaturmien estämiseksi.
- △ Suuret paine-erot kylmä- ja kuumavesiliitäntöjen välillä on tasattava.

## Asennusohjeet

- Ennen asennusta on tarkastettava tuotteen mahdolliset kuljetusvahingot. Asennuksen jälkeen kuljetus- ja pintavaurioita ei hyväksytä.
- Putket ja hana on asennettava, huuhdeltava ja tarkastettava voimassa olevien standardien mukaisesti.
- Jokaisessa maassa on noudatettava siellä päteviä asennusohjeita.
- Hana on asennettava eristettynä ja äänenvaimennettuna.

## Merkin kuvaus



Älä käytä etikkahappopitoista silikonia!



**Mitat** (katso sivu 18)



**Varaosat** (katso sivu 20)

## Erityisvaruste (ei kuulu toimitukseen)



Pidennys 25 mm #96370000 (katso sivu 20)



**Valmissarja** (katso sivu 20)



**Asennusesimerkkejä** (katso sivu 19)





## Säkerhetsanvisningar

- △ Handskar ska bäras under monteringsarbetet så att man kan undvika kläm- och skärskador.
- △ Stora tryckskillnader mellan anslutningarna för varmt och kallt vatten måste utjämnas.

## Monteringsanvisningar

- Det måste undersökas om produkten har transportskador innan den monteras. Efter monteringen accepteras inga transport- eller ytskiktsskador.
- Ledningarna och blandaren måste monteras, spolas igenom och kontrolleras enligt de gällande normerna.
- De installationsriktlinjer som gäller i länderna ska följas.
- Blandaren måste monteras isolerat och ljudabsorberande.

## Symbolförklaring



Använd inte silikon som innehåller ättiksyra!



**Måtten** (se sidan 18)



**Reservdelar** (se sidan 20)

**Specialtillbehör** (medföljer ej leveransen)



Förlängning 25 mm #96370000 (se sidan 20)



**Färdigset** (se sidan 20)



**Monteringsexempel** (se sidan 19)

## Saugumo technikos nurodymai

- △ Apsaugai nuo užspaudimo ir įsijovimo montavimo metu mūvėkite pirštines.
- △ Turi būti išlyginti šalto ir karšto slėgio nelygumai.

## Montavimo instrukcija

- Prieš montuojant būtina patikrinti, ar gaminys nebuvo pažeistas transportavimo metu. Sumontavus pretenzijos dėl transportavimo ir paviršiaus pažeidimų nepriimamos.
- Vamzdžiai ir sujungimai turi būti montuojami, plaunami ir tikrinami pagal galiojančias normas.
- Laikykites atitinkamoje šalyje galiojančių direktyvų dėl įrengimo.
- Maišytuvus turi būti sumontuotas izoliuotai ir naudojant garso izoliaciją.

## Simbolio aprašymas



Nenaudokite silikono, kurio sudėtyje yra acto rūgšties!



**Išmatavimai** (žr. psl. 18)



**Atsarginės dalys** (žr. psl. 20)

**Specialūs priedai** (nėra pridedama)



Ilgiklis 25 mm #96370000 (žr. psl. 20)



**Viršinkinė** (žr. psl. 20)



**Montavimo pavyzdžiai** (žr. psl. 19)

## Montering

(se sidan 18) 

## Montavimas

(žr. psl. 18) 



## Güvenlik uyarıları

- ⚠ Montaj esnasında ezilme ve kesilme gibi yaralanmaları önlemek için eldiven kullanılmalıdır.
- ⚠ Sıcak ve soğuk su bağlantıları arasında büyük basınç farklılıkları varsa, bu basınç farklılıklarının dengelenmesi gerekir.

## Montaj açıklamaları

- Montaj işleminden önce ürün nakliye hasarları yönünden kontrol edilmelidir. Montaj işleminden sonra nakliye veya yüzey hasarları için sorumluluk üstlenilmemektedir.
- Boruların ve armatürün montajı, yıkanması ve kontrolü geçerli normlara göre yapılmalıdır.
- Ülkelerde geçerli kurulum yönetmeliklerine riayet edilmelidir.
- Armatür izoleli ve ses ayırmalı olarak monte edilmelidir.

## Simge açıklaması



Asetik asit içeren silikon kullanmayın!



**Ölçüleri** (bakınız sayfa 18)



**Yedek Parçalar** (bakınız sayfa 20)

## Özel aksesuarlar

(Teslimat kapsamına dahil değildir)



Uzatma 25 mm  
#96370000 (bakınız sayfa 20)



**Dış set** (bakınız sayfa 20)



**Montaj Örneği** (bakınız sayfa 19)

## Garanti Belgesi

### Üretici veya İthalatçı Firmanın

Unvanı: Hansgrohe Armatür Ltd. Şti  
Adresi: Fulya Mahallesi Bahçeler Sokak Efe han 20/C  
Mecidiyeköy Şişli İstanbul  
Telefonu: (0-212) 273 07 30  
Faks: (0-212) 273 07 40  
web adresi: www.hansgrohe.com.tr

## Malın

Markası: Hansgrohe  
Cinsi: Sıhhi tesisat malzemesi  
Garanti Süresi: 2 YIL  
Azami Tamir Süresi: 20 İş günü

## Genel Müdür

Albert Emlek

Satıcı Firmanın:

Unvanı:

Adresi:

Telefonu:

Faks:

e-posta:

Fatura Tarih ve Sayısı:

Marka ve Modeli:

Teslim Tarihi ve Yeri:

Yetkilinin İmzası:

Firmanın Kaşesi:

Bu bölümü, ürünü aldığınız Yetkili Satıcı imzalayacak ve kaşeleyecektir.

## Montajı

(bakınız sayfa 18)





## Sigurnosne upute

- ⚠ Prilikom montaže se radi sprječavanja prignječenja i posjekotina moraju nositi rukavice.
- ⚠ Velika razlika u pritisku između vruće i hladne vode mora biti izbalansirana.

## Upute za montažu

- Prije montaže mora se provjeriti je li proizvod oštećen prilikom transporta. Nakon ugradnje se ne priznaju nikakve reklamacije koje se odnose na površinska i transportna oštećenja.
- Cijevi i armatura moraju biti postavljeni, isprani i testirani prema važećim normama.
- Obvezno se moraju uvažiti propisi o instalacijama koji vrijede u dotičnoj zemlji.
- Montirana armatura mora biti izolirana i zvučno odvojena.

## Opis simbola

 Nemojte koristiti silikon koji sadrži octenu kiselinu!

 **Mjere** (pogledaj stranicu 18)

 **Rezervni djelovi**  
(pogledaj stranicu 20)

**Posebni pribor** (Nije sadržano u isporuci!)

 Produljenje 25 mm  
#96370000 (pogledaj stranicu 20)

 **Završni set** (pogledaj stranicu 20)

 **Primjeri instalacija**  
(pogledaj stranicu 19)

## Instrucțiuni de siguranță

- ⚠ La montare utilizați mănuși pentru evitarea contuziunilor și tăierii mâinilor.
- ⚠ Diferențele de presiune mari între alimentarea cu apă rece și apă caldă trebuie echilibrate.

## Instrucțiuni de montare

- Înainte de instalare verificați, dacă produsul prezintă deteriorări de transport. După instalare garanția nu acoperă deteriorările de transport și cele de suprafață.
- Conductele și bateriile trebuie montate, spălate și verificate conform normelor în vigoare.
- Respectați reglementările referitoare la instalare valabile în țara respectivă.
- Armătura trebuie montată cu izolație termică și fonică.

## Descrierea simbolurilor

 Nu utilizați silicon cu conținut de acid acetic!

 **Dimensiuni** (vezi pag. 18)

 **Piese de schimb** (vezi pag. 20)

**Accesorii opționale**  
(nu este inclus în setul livrat)

 Prelungitor 25 mm #96370000 (vezi pag. 20)

 **Set complet** (vezi pag. 20)

 **Exemple de montare** (vezi pag. 19)

## Sastavljanje

(pogledaj stranicu 18) 

## Montare

(vezi pag. 18) 



## Υπ δείξεις σφ λεί ς

- △ Για να αποφύγετε τραυματισμούς κατά τη συναρμολόγηση πρέπει να φοράτε γάντια.
- △ Οι διαφορές της πίεσης μεταξύ της σύνδεσης κρύου και ζεστού νερού θα πρέπει να αντισταθμίζονται.

## Οδηγίες σ ν ρμ λόγησης

- Πριν τη συναρμολόγηση πρέπει να εξεταστεί το προϊόν για ζημιές μεταφοράς. Μετά την εγκατάσταση δεν αναγνωρίζονται ζημιές από τη μεταφορά ή επιφανειακές ζημιές.
- Οι σωλήνες και η μπαταρία πρέπει να τοποθετηθούν σύμφωνα με τα ισχύοντα πρότυπα, να τεθούν υπό πίεση και να δοκιμαστούν.
- Θα πρέπει να τηρούνται οι οδηγίες εγκατάστασης που ισχύουν σε κάθε κράτος.
- Η μπαταρία πρέπει να τοποθετείται με κατάλληλη διάταξη ηχομόνωσης.

## Περιγραφή σ μβόλων



Μην χρησιμοποιείτε σιλικόνη που περιέχει οξικό οξύ!



**Δι στάσεις** (βλ. Σελίδα 18)



**Αντ λλ κτικά** (βλ. Σελίδα 20)

**Ειδικά ξεσ άρ** (δεν περιλαμβάνεται στον παραδοτέο εξοπλισμό)



Επιμήκυνση 25 mm  
#96370000 (βλ. Σελίδα 20)



**Σετ μηχ νισμ ύ** (βλ. Σελίδα 20)



**Π ρ δείγμ τ σ ν ρμ λόγησης**  
(βλ. Σελίδα 19)



## Varnostna opozorila

- △ Pri montaži je treba nositi rokavice, da se preprečijo poškodbe zaradi zmečkanja ali urezov.
- △ Velike razlike v tlaku med priključkom za mrzlo in priključkom za toplo vodo je potrebno izravnati.

## Navodila za montažo

- Pred montažo je treba izdelek preveriti glede morebitnih transportnih poškodb. Po vgradnji transportne ali površinske poškodbe ne bodo več priznane.
- Cevi in armaturo je treba montirati, izprati in preveriti po veljavnih standardih.
- Upoštevaty je treba pravilnike o inštalacijah, ki veljajo v posamezni državi.
- Armaturo morate montirati izolirano in zvočno neprepustno.

## Opis simbola



Ne smete uporabiti silikona, ki vsebuje ocetno kislino!



**Mere** (glejte stran 18)



**Rezervni deli** (glejte stran 20)

**Poseben pribor** (Ni vključeno)



Podaljšek 25 mm #96370000 (glejte stran 20)



**Zaključna garnitura** (glejte stran 20)



**Primeri montaže** (glejte stran 19)

## Σ ν ρμ λόγηση

(βλ. Σελίδα 18)

## Montaža

(glejte stran 18)



## Ohutusjuhised

- △ Kandke paigaldamisel muljumis- ja löikevigastuste vältimiseks kindaid.
- △ Kui külma ja kuuma vee ühenduste surve on väga erinev, tuleb need tasakaalustada.

## Paigaldamisjuhised

- Enne paigaldamist tuleb toodet kontrollida transportdikahjustuste osas. Pärast paigaldamist ei tunnustata enam transporti- või pinnakahjustuste kaebuseid.
- Voolikute ja segisti paigaldamisel, loputamisel ja kontrollimisel tuleb lähtuda kehtivatest normatiividest.
- Vastavas riigis kehtivaid paigalduseeskirju tuleb järgida.
- Armatuur tuleb paigaldada isoleeritult ja helikindlalt.

## Sümbolite kirjeldus



Ärge kasutage äädikhapet sisaldavat silikooni!



**Mõõtude** (vt lk 18)



**Varuosad** (vt lk 20)

## Spetsiaalne lisavarustus

(ei sisaldu komplektis)



pikendus 25 mm #96370000 (vt lk 20)



**Valmiskomplekt** (vt lk 20)



**Paigalduse näited** (vt lk 19)

## Drošības norādes

- △ Montāžas laikā, lai izvairītos no saspiedumiem un iegriezumiem, nepieciešams nēsāt cimdus.
- △ Jāizlīdzina spiediena atšķirības starp aukstā un karstā ūdens pievadiem.

## Norādījumi montāžai

- Pirms montāžas nepieciešams pārbaudīt, vai produktam transportēšanas laikā nav radušies bojājumi. Pēc iebūvēšanas bojājumi, kas radušies transportēšanas laikā, vai virsmas bojājumi netiek atzīti.
- Cauruljadi un armatūra ir jāuzstāda, jāizskalo un jāpārbauda saskaņā ar spēkā esošajiem standartiem.
- Jāievēro attiecīgās valstīs spēkā esošās montāžas prasības.
- Armatūra montējama izolēti un ar skaņas izolāciju.

## Simbolu nozīme



Neizmantojiet silikonu, kas satur etiķskābi!



**Izmērus** (skat. lpp. 18)



**Rezerves daļas** (skat. lpp. 20)

## Speciāli aksesuāri

(komplektā netiek piegādāts)



Pagarinājums 25 mm  
#96370000 (skat. lpp. 20)



**Komplekts** (skat. lpp. 20)



**Montāžas piemēri** (skat. lpp. 19)

## Paigaldamine

(vt lk 18) 

## Montāža

(skat. lpp. 18) 



## Sigurnosne napomene

- △ Prilikom montaže se radi sprečavanja prignječenja i posekotina moraju nositi rukavice.
- △ Velika razlika u pritisku između vruće i hladne vode mora biti izbalansirana.

## Instrukcije za montažu

- Pre montaže se mora proveriti da li je proizvod oštećen pri transportu. Nakon ugradnje se ne priznaju nikakve reklamacije koje se odnose na površinska i transportna oštećenja.
- Vodovi i armatura moraju biti postavljeni, isprani i testirani prema važećim normama.
- Treba se pridržavati propisa koji u određenim zemljama važe za instalacije.
- Armatura se mora montirati tako da bude izolovana i zvučno odvojena.

## Opis simbola



Nemojte koristiti silikon koji sadrži sircetnu kiselinu!



**Mere** (vidi stranu 18)



**Rezervni delovi** (vidi stranu 20)

**Poseban pribor** (Nije sadržano u isporuci)



Produžetak 25 mm #96370000 (vidi stranu 20)



**Završni set** (vidi stranu 20)



**Primeri montaže** (vidi stranu 19)



## Sikkerhetshenvisninger

- △ Bruk hansker under montasjen for å unngå klem- og kuttskader.
- △ Store trykkdifferanser mellom kaldt- og varmtvannstilkoblinger skal utlignes.

## Montagehenvisninger

- Før montasjen skal produktet sjekkes for transportskader. Etter monteringen aksepteres ikke noen transport- eller overflateskader.
- Ledningene og armaturen skal monteres, spyles og sjekkes iht. de gyldige normer.
- Gjeldende retningslinjer for rørleggerarbeid i de enkelte land skal følges.
- Armaturen skal monteres isolert og støyfrikoblet.

## Symbolbeskrivelse



Ikke bruk silikon som inneholder eddiksyre!



**Mål** (se side 18)



**Servicedeler** (se side 20)

**Ekstratilbehør** (ikke med i leveransen)



Forlengelse 25 mm #96370000 (se side 20)



**Ferdigsett** (se side 20)



**Montasje-eksempel** (se side 19)

## Montaža

(vidi stranu 18)

## Montasje

(se side 18)



## Ук з ния з безоп сност

- △ При монтажа трябва да се носят ръкавици, за да се избегнат наранявания поради притискане или порязване.
- △ Големите разлики в налягането между изводите за студената и топлата вода трябва да се изравняват.

## Ук з ния з монт ж

- Преди монтажа продуктът трябва да се провери за транспортни щети. След монтажа не се признават транспортни или повърхностни щети.
- Тръбопроводите и арматурата трябва да се монтират, промият и проверят в съответствие с валидните норми.
- Трябва да бъдат спазвани валидните в съответните страни предписания за инсталиране.
- Арматурата трябва да се монтира изолирана и не свързана с шум.

## Опис ние н символите

 Не използвайте силикон, съдържащ оцетна киселина!

 **Р змери** (вижте стр. 18)

 **Сервизни ч сти** (вижте стр. 20)

**Специ лни прин длежности**  
(не се съдържа в обема на доставка)

 Удължител 25 мм #96370000 (вижте стр. 20)

 **Готов н бор** (вижте стр. 20)

 **Примери з монт ж** (вижте стр. 19)

## Udhëzime sigurie

- △ Për të evituar lëndimet e pickimeve ose të prerjeve gjatë procesit të montimit duhet që të vishni doreza.
- △ Ndryshimet e mëdha të presionit mes lidhjeve të ujit të ftohtë dhe atij të ngrohtë duhen ekuilibruar.

## Udhëzime për montimin

- Përpара montimit duhet që produkti të kontrollohet për dëmtime nga transporti. Pas instalimit nuk do të njihet asnjë dëmtim nga transporti ose dëmtim i sipërfaqes.
- Tubacionet dhe rubinetet duhet që të montohen, të shpëlahen dhe të kontrollohen sipas standardeve në fuqi
- Duhet të respektohen linjat udhëzuese të instalimit, të vlefshme për vendet respektive.
- Valvula duhet të izolohet dhe të izoluar akustikisht montuar.

## Përshkrimi i simbolit

 Mos përdorni silikon që në përbërje ka acid acetik.

 **Përmasat** (shih faqen 18)

 **Pjesët e servisit** (shih faqen 20)

**Pajisje të posaçme**  
(nuk përfshihet në vëllimin e furnizimit)

 Zgjatësi 25 мм #96370000 (shih faqen 20)

 **Komplet i gatshëm** (shih faqen 20)

 **Shembuj të montimit** (shih faqen 19)

**Монт ж**  
(вижте стр. 18) 

**Montimi**  
(shih faqen 18) 

**تنبيهات الأمان**

- ⚠ يجب إرتداء قفازات لليد أثناء التركيب لتجنب حدوث أخطار الإنحشار أو الجروح.
- ⚠ يجب أن يكون تيار الماء الساخن والماء البارد متعادلين في الضغط.

**تعليمات التركيب**

- قبل القيام بعملية التركيب، يجب فحص المنتج للتأكد من خلوه من أية تلفيات ناتجة عن النقل. بعد القيام بعملية التركيب، لن يتم الاعتراف بوجود أية تلفيات سطحية أو تلفيات ناتجة عن عملية النقل.
- يجب تركيب وغسيل واختبار التوصيلات وخلطات المياه طبقاً للمعايير السارية.
- يجب مراعاة القواعد الخاصة بالتركيب وأعمال السباكة وفقاً للوائح الخاصة بكل بلد.
- يجب تركيب خلاط المياه بعد عزله وفصله عن الاحتكاكات بمواد البناء داخل المكان الذي يركب به.

**وصف الرمز**

⚠ هام! لا تستخدم السليكون الذي يحتوي على أمضاض!

📏 أبعاد (راجع صفحة 18)

🔧 قطع الغيار (راجع صفحة 20)

📋 ملحقات خاصة (غير مدرج مع المحتويات المسلمة)

🔧 وصلة إطالة 25 مم #96370000 (راجع صفحة 20)

🔧 مجموعة كاملة. (راجع صفحة 20)

📌 مثال على التركيب (راجع صفحة 19)

**Biztonsági utasítások**

- ⚠ A szerelésnél a zúzódások és vágási sérülések elkerülése érdekében kesztyűt kell viselni.
- ⚠ A hidegvíz- és a melegvíz-csatlakozások közötti nagy nyomáskülönbséget kikell egyenlíteni!

**Szerelési utasítások**

- A szerelés előtt ellenőrizni kell, hogy a terméknek nincs-e szállítási sérülése. Beépítés után a szállítási- vagy felületi sérüléseket nem ismerik el.
- A vezetékeket és a csaptelepet az érvényes szabványoknak megfelelően kell felszerelni, öblíteni és ellenőrizni
- Az egyes országokban érvényes installációs irányelveket be kell tartani.
- A csaptelepet szigetelve és zajszigetelve kell felszerelni.

**Szimbólumok leírása**

🔧 Ne használjon ecetsavtartalmú szilikont!

📏 **Méretet** (lásd a oldalon 18)

🔧 **Tartozékok** (lásd a oldalon 20)

**Egyéb tartozék**

(a szállítási egység nem tartalmazza)

🔧 Hosszabbítás 25 mm #96370000 (lásd a oldalon 20)

**A kész szerelvény**

(lásd a oldalon 20)

📌 **Szerelési példák** (lásd a oldalon 19)

**التركيب**

(راجع صفحة 18)

**Szerelés**

(lásd a oldalon 18)





### 安全上の注意

- △ 施工の際は手を挟んだり怪我をしないように、手袋をはめてください。
- △ 給水・湯の圧力差は0.1(MPa)以内としてください。

### 施工上の注意

- 製品の施工前に輸送でのダメージがないか確認してください。施工後のキズ等のお申し出はお断りさせて頂いています。
- 配管と水栓は、関連法規に従って施工、洗浄、および試験を行ってください。
- 施工行う地域に適用される関連法規をお守りください。
- 水栓の取付は、絶縁と遮音について考慮されている必要があります。

### アイコンの説明

 酢酸系シリコンをご使用にならないでください!

 寸法 (次のページを参照 18)

 スペアパーツ (次のページを参照 20)

スペシャルパーツ (別手配部品)

 25 mm延長部材 #96370000  
(次のページを参照 20)

 化粧部 (次のページを参照 20)

 施工例 (次のページを参照 19)

## 施工方法

(次のページを参照 18) 



Schallentkopplung / silencieux / noise reduction / sorbente acusticor / Silenciador / ruisdemper / Lydudkoblingen / Isolamento acústico / Odsprężenie akustyczne / Zvukové odstínění / Zvukové odtienenie / 隔音装置 / Шумоизоляция / Zajmentesítő / Äänieriste / Isolering / Garso slopinimas / Zvučna izolacija / Ses ayırma / Izolare fonică / Ηχομόωση / Ločitev zvoka / Mürasolatsioon / Skaņu slāpējošs pieslēgums / Zvučna izolacija / Støyavkobling / Заглушитель / Ndarësi i ekos / تحويل صدى الصوت / 遮音

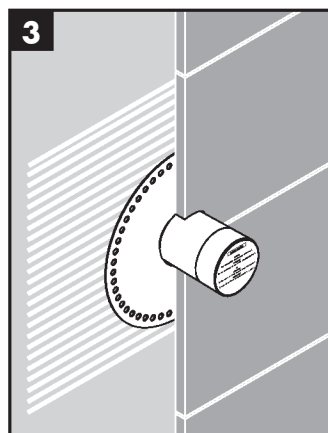
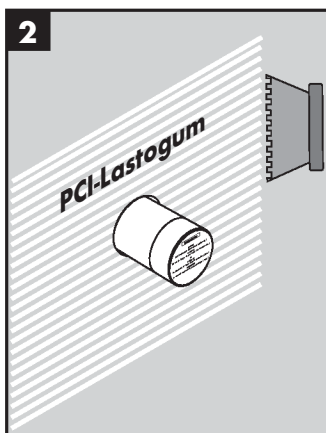
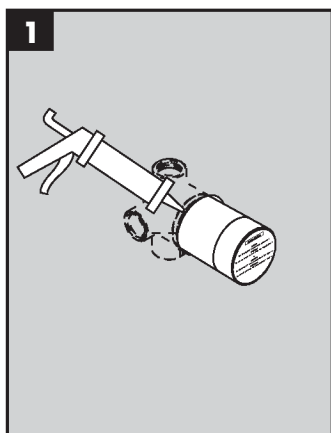
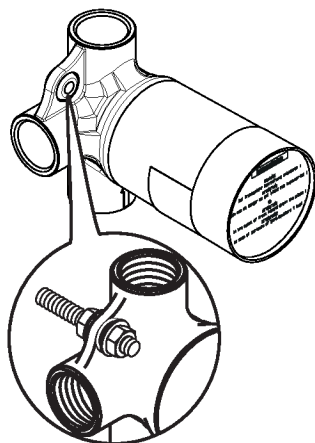
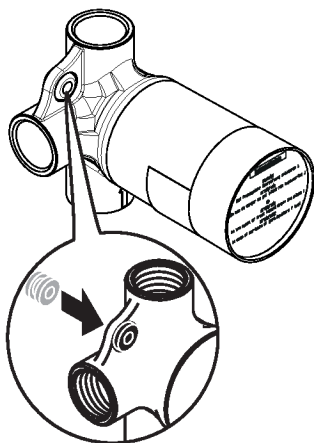

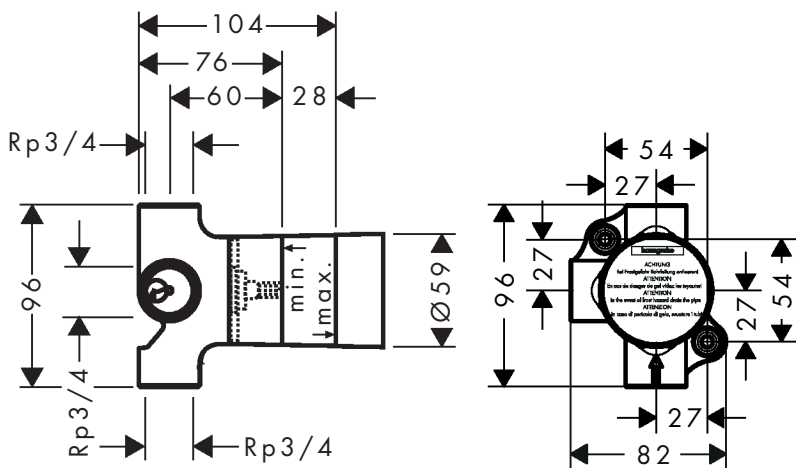
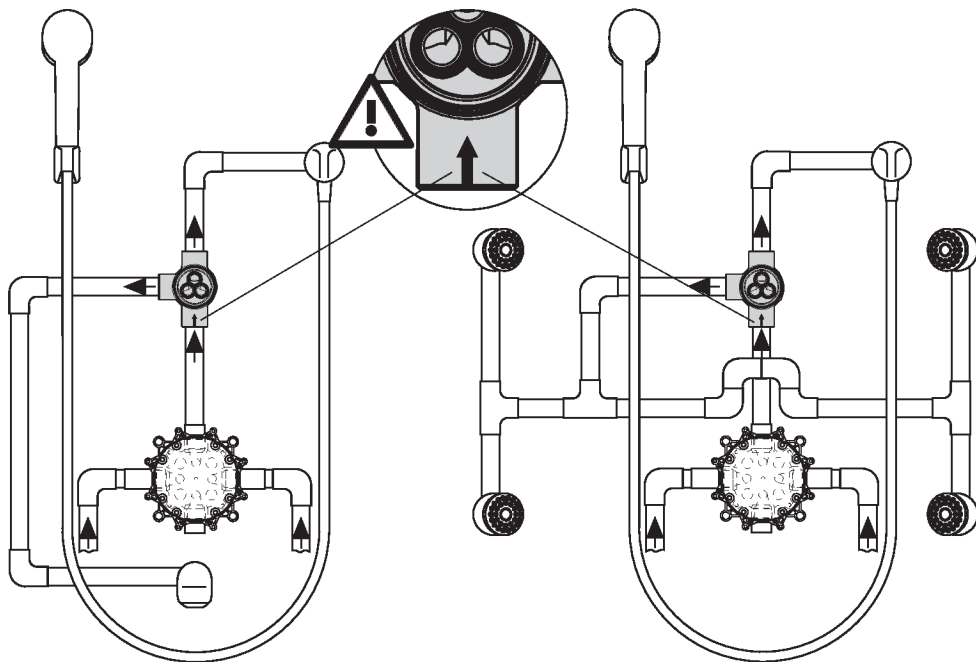

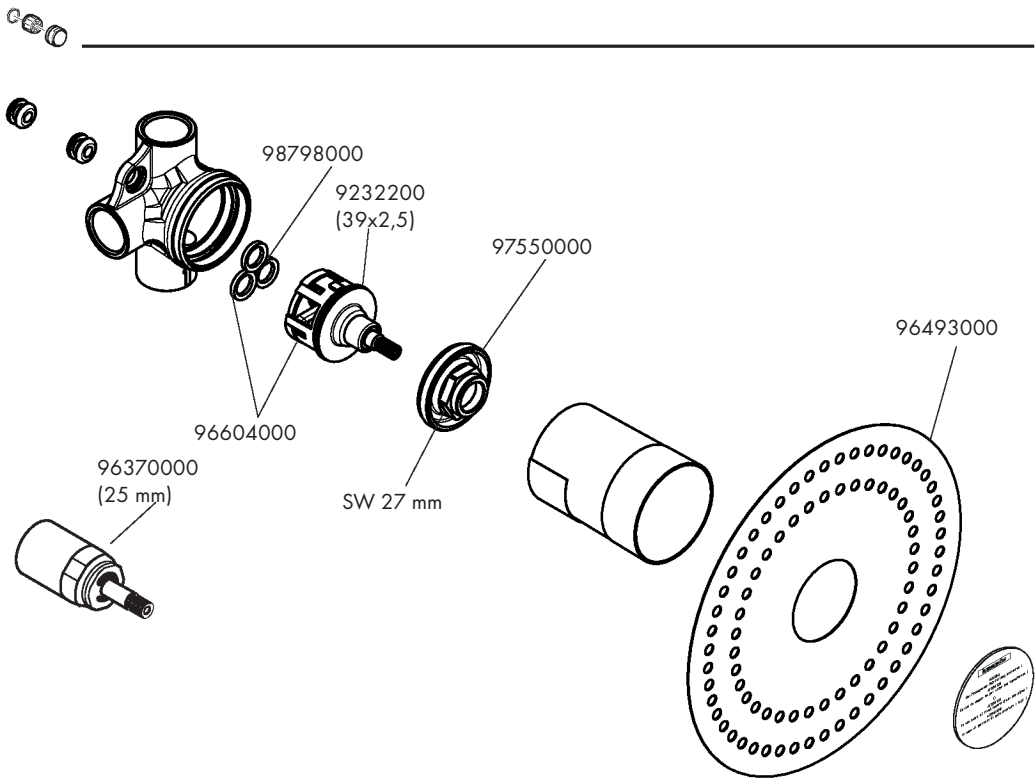

**Trio / Quattro PuraVida**  
15937XXX

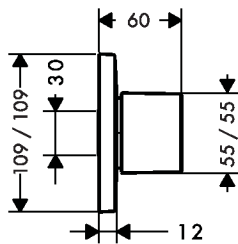

**Trio / Quattro S**  
15932XXX

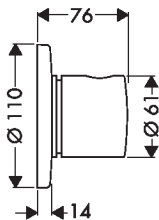

**Trio / Quattro Metris**  
31634XXX

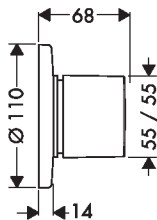

**hansgrohe**