

Technische Daten/ Technical Data

KLUDI DECUS

concealed single lever basin mixer
DN 15

Ref.: 54245N575

Finishes:

N5 Stainless Brushed Nickel PVD

Product description

Manufacturer KLUDI GmbH & Co. KG

Typ: KLUDI DECUS

concealed single lever basin mixer

Ref.: 54245N575

concealed single lever basin mixer

projection 240mm

trim set without pre-installation set

for pre-installation set KLUDI Ref.: 38241

wall mounted

solid lever, metal

aerator, S-Pointer M24 PCA

flow rate at 3 bar 4,5 l/min.

fixed spout

EU taxonomy: max. 6 l/min. -

Substantial Contribution (SC) possible

Produktabbildung/ Product picture



Maßzeichnung/ Dimensional drawing

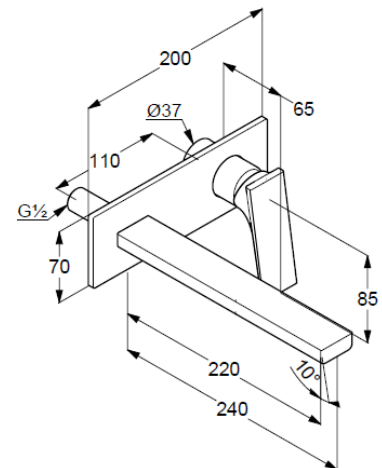

Durchfluss/ Flow rate

