

CLASSICS

Washbasin bowl, glazed steel, without tap bank, without tap hole, without overflow, including fixing set, drain valve



DIMENSIONS

Length	300 mm
Width	300 mm
Height	110 mm

COLOUR AND FINISH

<input type="checkbox"/>	000 White
--------------------------	-----------

OPTIONS

112 - without tap hole, without overflow

Back glazed

Bowl length (mm) : 300

Bowl position : Central

Bowl width (mm) : 300

Fixing kit : Included

Glazed base

Installation type : Bowl / On countertop

Internal Shape : 1 - Round

Material : Glazed steel

Net weight (kg) : 2.3

Overflow type : Standard

Plug and Waste : Included

Shape : Round

Taphole configuration : No tapholes

Trap : Not included

Waste : Included

Weight (Kg) : 2.3

Without overflow

TECHNICAL DRAWINGS

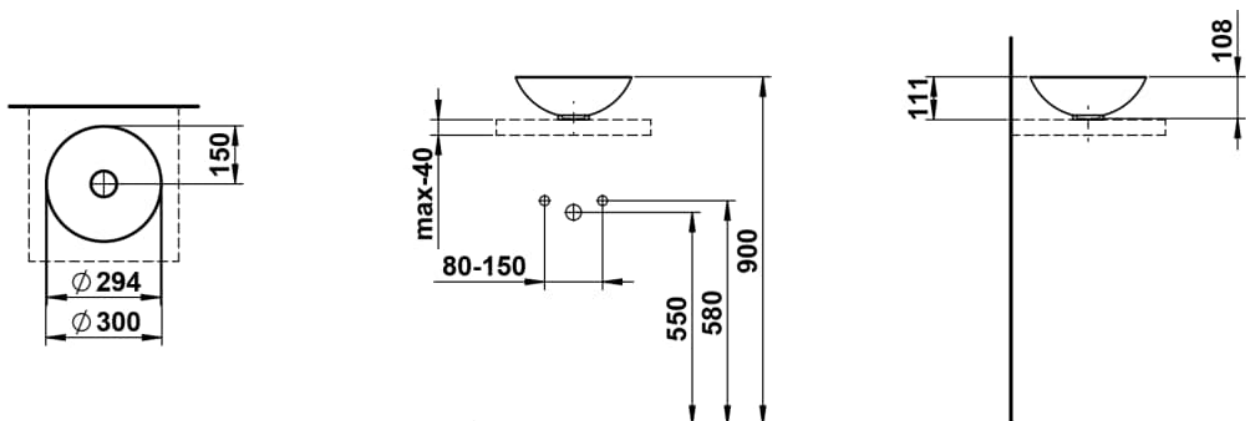

CLASSICS

The washbasins of the CLASSICS series combine iconic design with an emotional depth that shapes the space—clear, authentic, unmistakable. Every detail reflects a clear design intention: restrained, yet full of character.

Reduced depths, precisely defined geometries, and finely proportioned basins made of glazed steel create a sense of visual calm—even in compact spaces. These washbasins integrate seamlessly into smaller layouts, contributing to the order and clarity of the overall architectural concept.

Designed for those who seek the extraordinary in everyday life—and who want their bathroom to make a personal statement.