

DIN EN 806  
DIN EN 1717  
DIN 1988  
Global  
Standards

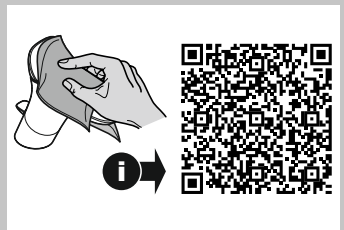

- (D) Montage- und Bedienanleitung
- (CN) 安装及操作指南
- (CZ) Návod k instalaci a k použití
- (E) Instrucciones de montaje y de manejo
- (EST) Paigaldamine ja kasutamine
- (F) Instructions de montage et d'utilisation
- (GB) Installation and operating instructions
- (GR) ΟΔΗΓΙΕΣ ΕΓΚΑΤΑΣΤΑΣΗΣ ΚΑΙ ΣΥΝΤΗΡΗΣΗΣ
- (H) Szerelési és használati utasítás
- (I) Istruzioni di montaggio e per l'uso
- (LT) Montavimo ir naudojimo instrukcija
- (LV) Montāžas un lietošanas instrukcija
- (NL) Montagehandleiding en Gebruiksaanwijzing
- (PL) Instrukcja montażu i obsługi
- (RO) Instrucțiuni de montaj și utilizare
- (RUS) Руководство по монтажу и эксплуатации
- (SK) Návod na montáž a obsluhu
- (SLO) Navodila za montažo in uporabo
- (UA) Інструкція по монтажу та експлуатації
- (UAE) تعليمات التركيب والتشغيل

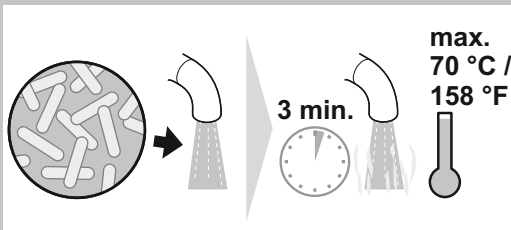
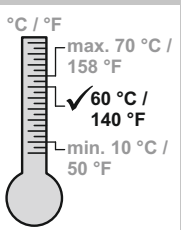
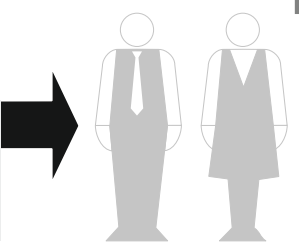
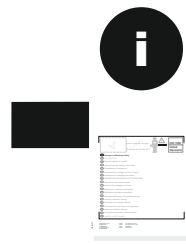
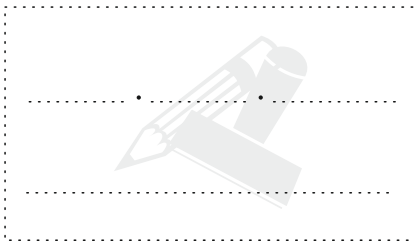
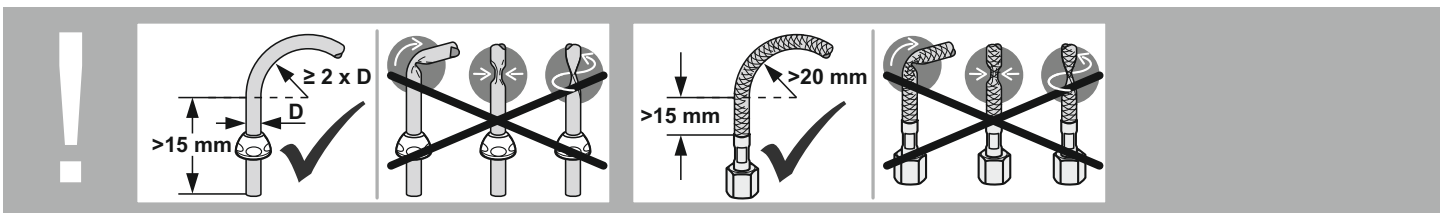
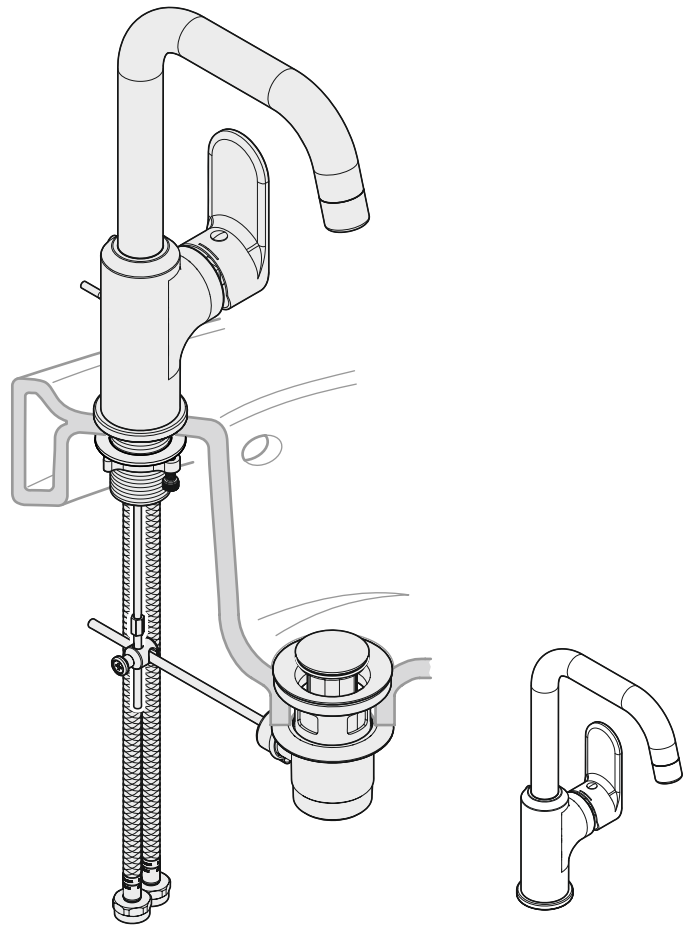

1.

