

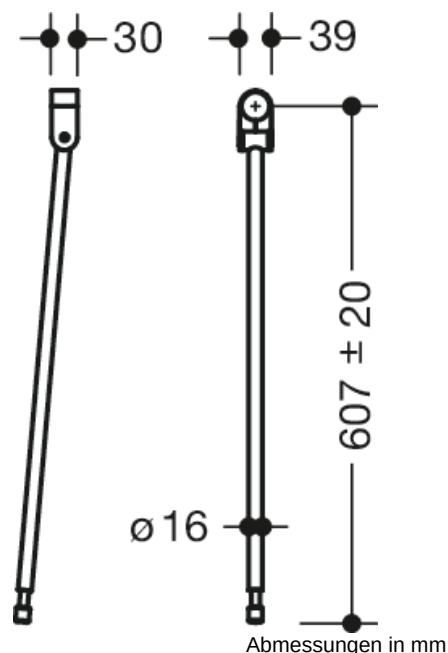

Abbildung ähnlich



Eigenschaften

Bodenstütze

- senkrechte Bodenstütze zur Nachrüstung an Stützklappgriffen und Wandstützgriffen 801.50...
- Montagehöhe 760 mm (zur Erfüllung der Höhenanforderungen nach DIN 18040)
- leichte Montage
- Anbindung aus hochglänzendem Polyamid nach HEWI Farbtabelle
- Stütze aus hochwertigem Edelstahl, Oberfläche matt geschliffen
- senkrechte Länge 607 mm
- Höhenanpassung im Bereich +/- 20 mm möglich
- wird gemäß CE- und UKCA-Verordnung (EU) 2017/745 über Medizinprodukte produziert















Auszeichnungen



Zertifikate



Farben/Oberflächen

 99 (Reinweiß)	 92 (Anthrazitgrau)	 74 (Apfelgrün)	 33 (Rubinrot)
 98 (Signalweiß)	 90 (Tiefschwarz)	 55 (Aquablau)	 18 (Senfgelb)
 97 (Lichtgrau)	 86 (Sand)	 50 (Stahlblau)	
 95 (Felsgrau)	 84 (Umbrä)	 36 (Koralle)	