

















	Dark Platinum gebürstet	10 105 970-99
	Chrom	10 105 970-00
	Gold (23,9kt)	10 105 970-01
	chrom gebürstet (04)	10 105 970-04
	Platin gebürstet	10 105 970-06
	Platin	10 105 970-08
	Messing (23kt Gold)	10 105 970-09
	Weiß matt	10 105 970-10
	weiß	10 105 970-12
	schwarz	10 105 970-13
	Gold gebürstet (23,9kt)	10 105 970-14
	Dark Brass matt	10 105 970-16
	Dark Bronze matt	10 105 970-17
	Dark Chrome	10 105 970-19
	Light Gold	10 105 970-26
	Light Gold gebürstet	10 105 970-27
	Messing gebürstet (23kt Gold)	10 105 970-28
	Schwarz matt	10 105 970-33
	chrom satin	10 105 970-41
	Bronze gebürstet	10 105 970-42
	Champagne gebürstet (22kt Gold)	10 105 970-46
	Champagne (22kt Gold)	10 105 970-47
	Cyprum	10 105 970-49
	Chrom gebürstet	10 105 970-93
	royalblau	10 105 970-36



## Siebventil 1 1/4" - Dark Platinum gebürstet

SERIENNEUTRAL

10 105 970 Produktversion ab 01.04.0205

Nur für Becken mit Überlauf geeignet.

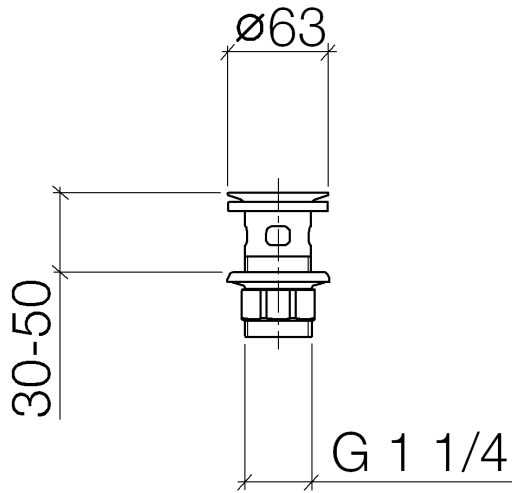

10 105 970 Produktversion ab 01.04.0205

Ersatzteile für die  
anderen  
Oberflächenvarianten  
finden Sie hier:  
Chrom

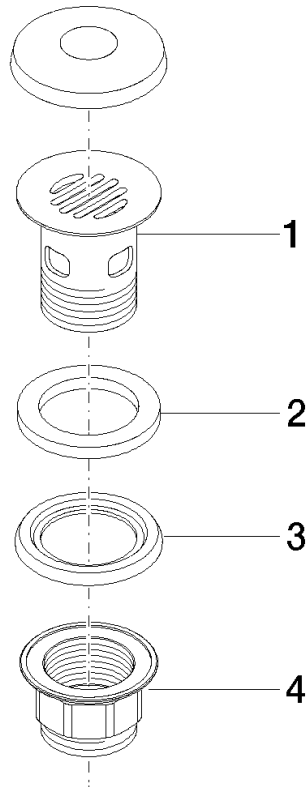

### Ersatzteilstückliste

Nr.	Artikelnummer	Benennung	Verbaumenge	Lieferzeit
2	09 14 05 039 90	Dichtung 43,5 x 62 x 6 mm -	1,00	2
1	09 11 01 027-99	Kelch für Ablaufgarnitur Siebventil 1 1/4" - Dark Platinum gebürstet	1,00	20
3	09 14 03 025 90	Dichtung Profildichtung Ø 64 x 6 mm -	1,00	2
4	09 23 10 020-99	Befestigung Ø 60 x 36,5 mm - Dark Platinum gebürstet	1,00	20