

























10 110 970 Produktversion ab 01.10.2023



	Dark Platinum gebürstet	10 110 970-99
	Chrom	10 110 970-00
	Gold (23,9kt)	10 110 970-01
	chrom gebürstet (04)	10 110 970-04
	Platin gebürstet	10 110 970-06
	Platin	10 110 970-08
	Messing (23kt Gold)	10 110 970-09
	Weiß matt	10 110 970-10
	weiß	10 110 970-12
	schwarz	10 110 970-13
	Gold gebürstet (23,9kt)	10 110 970-14
	Dark Brass matt	10 110 970-16
	Dark Bronze matt	10 110 970-17
	Dark Chrome	10 110 970-19
	Light Gold	10 110 970-26
	Light Gold gebürstet	10 110 970-27
	Messing gebürstet (23kt Gold)	10 110 970-28
	Schwarz matt	10 110 970-33
	chrom satin	10 110 970-41
	Bronze gebürstet	10 110 970-42
	Champagne gebürstet (22kt Gold)	10 110 970-46
	Champagne (22kt Gold)	10 110 970-47
	Cyprum	10 110 970-49
	Chrom gebürstet	10 110 970-93
	royalblau	10 110 970-36



## Siebventil 1 1/4" - Dark Platinum gebürstet

SERIENNEUTRAL

10 110 970 Produktversion ab 01.10.2023

Nur für Becken ohne Überlauf geeignet.

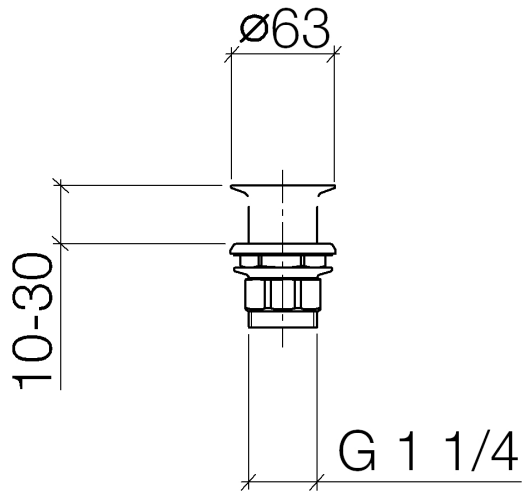

10 110 970 Produktversion ab 01.10.2023

Ersatzteile für die  
anderen  
Oberflächenvarianten  
finden Sie hier:  
Chrom

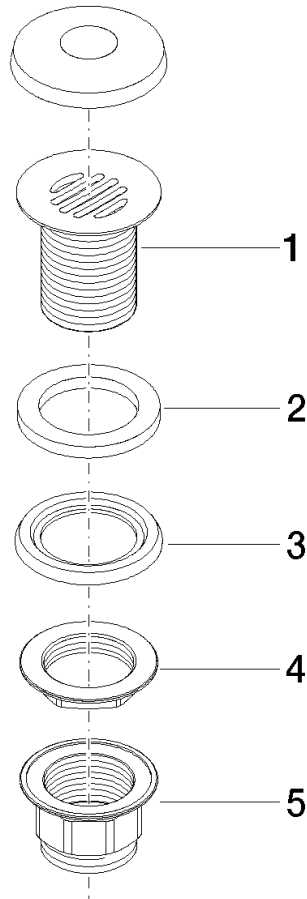

**Ersatzteilstückliste**

Nr.	Artikelnummer	Benennung	Verbaumenge	Lieferzeit
3	09 14 03 025 90	Dichtung Profildichtung Ø 64 x 6 mm -	1,00	2
2	09 14 05 039 90	Dichtung 43,5 x 62 x 6 mm -	1,00	2
1	09 11 01 025-99	Kelch für Ablaufgarnitur 1 1/4" - Dark Platinum gebürstet	1,00	20
5	09 23 10 020-99	Befestigung Ø 60 x 36,5 mm - Dark Platinum gebürstet	1,00	20
4	09 23 10 017 90	Befestigung mit Bund Verschraubung 1 1/4" -	1,00	2