

## Technische Daten/ Technical Data

### KLUDI DECUS

concealed single lever basin mixer  
DN 15

Ref.: 542453975

Finishes:  
39 matt black

Product description  
Manufacturer KLUDI GmbH & Co. KG  
Typ: KLUDI DECUS  
concealed single lever basin mixer  
Ref.: 542453975

concealed single lever basin mixer  
projection 240mm  
trim set without pre-installation set  
for pre-installation set KLUDI Ref.: 38241  
wall mounted  
solid lever, metal  
aerator, S-Pointer M24 PCA  
flow rate at 3 bar 4,5 l/min.  
fixed spout  
EU taxonomy: max. 6 l/min. -  
Substantial Contribution (SC) possible

### Produktabbildung/ Product picture



### Maßzeichnung/ Dimensional drawing

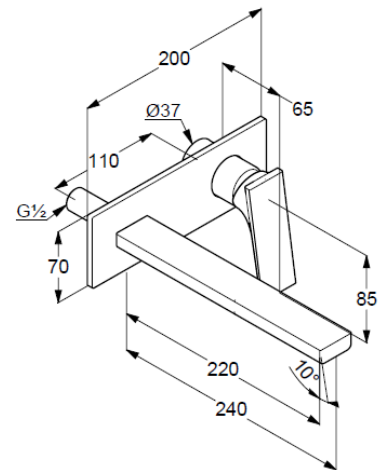

### Durchfluss/ Flow rate

