







36 607 671 Produktversion ab 01.04.2024

- Rosette Ø 60 mm
- Oberteil mit ablängbarer Spindel und Hülse



	Schwarz matt	36 607 671-33
	Chrom	36 607 671-00
	Platin gebürstet	36 607 671-06
	Dark Chrome	36 607 671-19
	Light Gold gebürstet	36 607 671-27
	Chrom gebürstet	36 607 671-93
	Dark Platinum gebürstet	36 607 671-99

Benötigtes Zubehör

	UP-Ventil 1/2" - •Min. Einbautiefe 105 mm •Max. Einbautiefe 150 mm	35 607 970 90
-----------------------------------------------------------------------------------	---------------------------------------------------------------------------------	---------------

36 607 671 Produktversion ab 01.04.2024

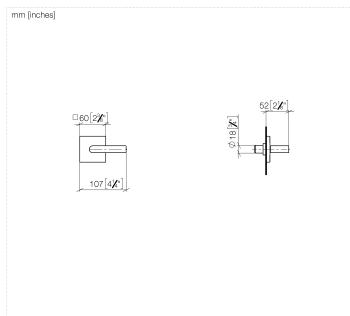

Codes & Standards

DIN 4109

ISO 3822

Ü-Zeichen

Zertifikate

LGA_38

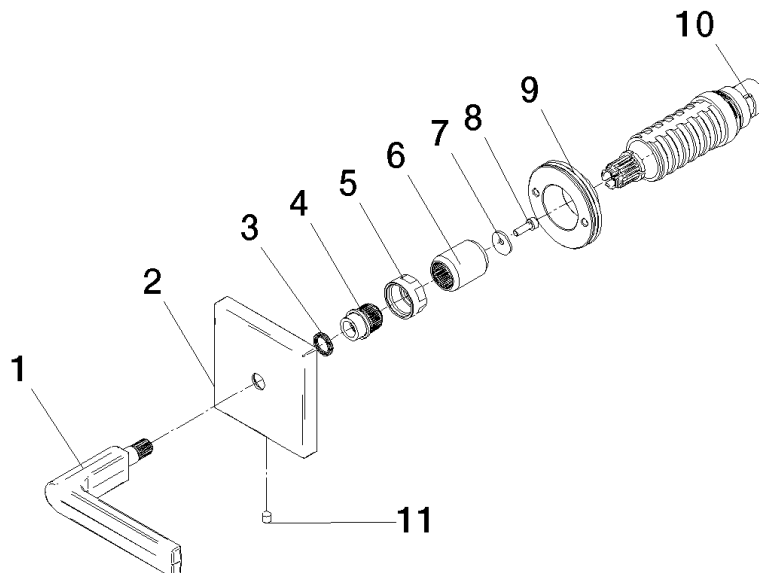

Ersatzteilstückliste

Nr.	Artikelnummer	Benennung	Verbaumenge	Lieferzeit
4	09 12 12 057 90	Rastbuchse weiß Ø 15 x 17 mm -	1,00	2
6	09 12 12 059 90	Hülse Ø 18 x 23 mm -	1,00	2
8	09 30 30 167 90	Befestigung Zylinderschraube mit Innensechskant M3 x 10 mm -	1,00	2
1	90 20 67 024 00-33	Hebel EHM 16 x 61 x 85 mm - Schwarz matt	1,00	20
5	09 23 30 074 90	Befestigung Mutter M16 x 1 -	1,00	2
9	90 21 02 108 00 90	Wandscheibe komplett -	1,00	2
2	09 27 78 033-33	Rosette	1,00	60
10	90 90 03 143 00 90	Oberteil , rechtsschließend 1/2" -	1,00	2
11	90 31 11 007 00 90	Befestigung Gewindestift mit Innensechskant M4 x 6 mm -	1,00	2
3	09 14 03 187 90	Ring -	1,00	2
7	09 30 11 193 90	Scheibe mit Verzahnung Ø 12 x 1 mm -	1,00	2