



























83 251 220 Produktversion ab 01.10.2023

- Ausladung 55 mm

Passt zu ELIO, ENO, MEM, META SQUARE, SYNC und TARA ULTRA



	Chrom	83 251 220-00
	Chrom	83 251 220-0015
	Chrom	83 251 220-0018
	chrom edelmatt	83 251 220-05
	Platin gebürstet	83 251 220-06
	Platin gebürstet	83 251 220-0618
	Platin	83 251 220-08
	Messing (23kt Gold)	83 251 220-09
	Messing (23kt Gold)	83 251 220-0918
	Weiß matt	83 251 220-10
	weiß	83 251 220-12
	schwarz	83 251 220-1315
	schwarz	83 251 220-13
	rot (15)	83 251 220-15
	Dark Brass matt	83 251 220-16
	Dark Bronze matt	83 251 220-17
	Dark Chrome	83 251 220-19
	Light Gold	83 251 220-26
	Light Gold gebürstet	83 251 220-27
	Messing gebürstet (23kt Gold)	83 251 220-28
	Schwarz matt	83 251 220-33
	chrom satin	83 251 220-41
	Bronze gebürstet	83 251 220-42
	Champagne gebürstet (22kt Gold)	83 251 220-46
	Champagne (22kt Gold)	83 251 220-47
	Chrom gebürstet	83 251 220-93
	Dark Platinum gebürstet	83 251 220-99



Haken - Chrom

SERIENNEUTRAL

83 251 220 Produktversion ab 01.10.2023



messing matt

83 251 220-29

83 251 220 Produktversion ab 01.10.2023

mm [inches]

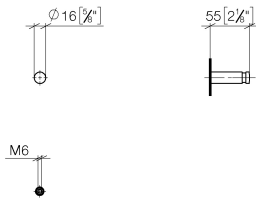

83 251 220 Produktversion ab 01.10.2023

Ersatzteile für die
anderen
Oberflächenvarianten
finden Sie hier:
Chrom

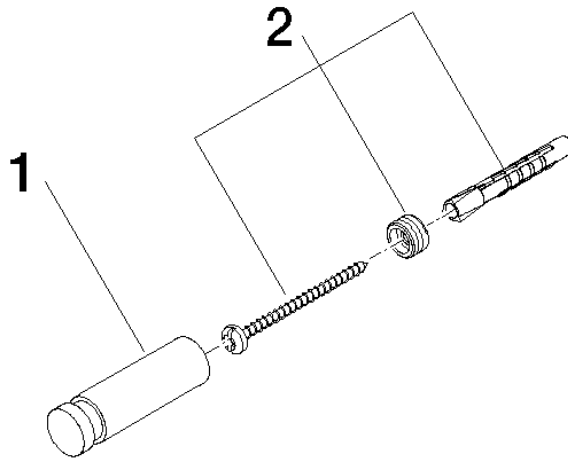

Ersatzteilstückliste

Nr.	Artikelnummer	Benennung	Verbaumenge	Lieferzeit
2	05 24 04 506 00 90	Befestigung für Haken -	1,00	2
1	08 18 60 505-00	Haken 16 x 16 x 55 mm - Chrom	1,00	-

Ersatzteil nicht mehr bestellbar, bitte bestellen Sie den Nachfolgeartikel