

INSTALLATION MANUAL

MONTAGEANLEITUNG
INSTRUCTIONS DE MONTAGE
ISTRUZIONI PER IL MONTAGGIO

**KNOW
HOW
INSTALLED**

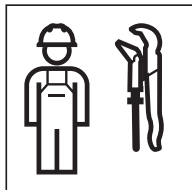



1

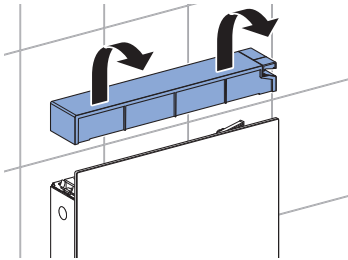

2

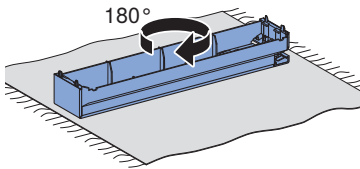

3

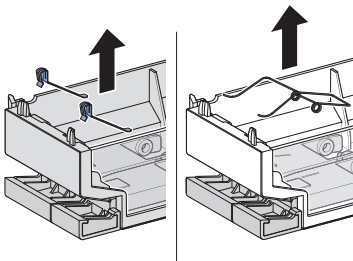

4

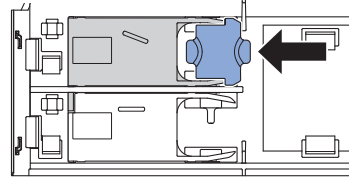
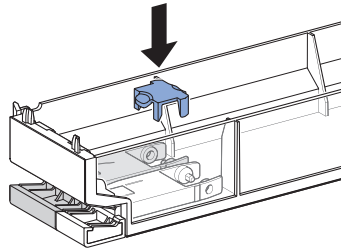

5

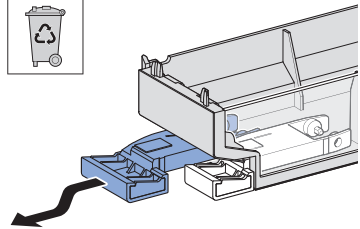

6

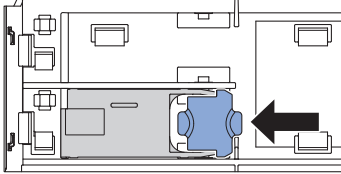
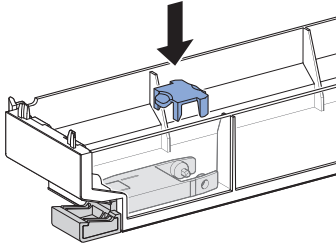

7

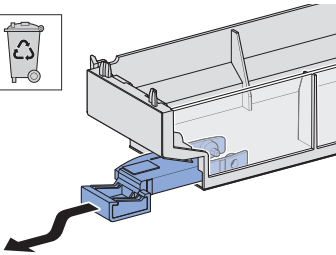

8

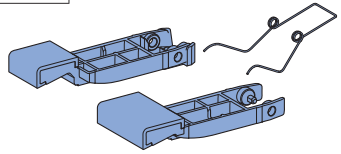

9

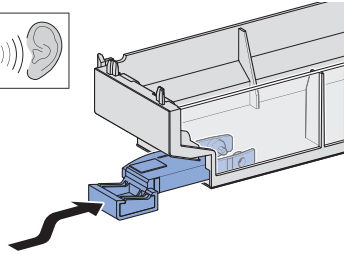

10

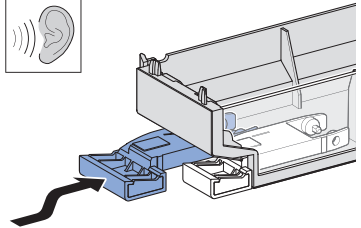

11

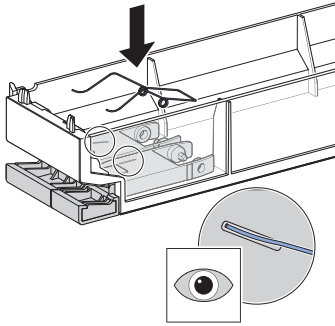

12

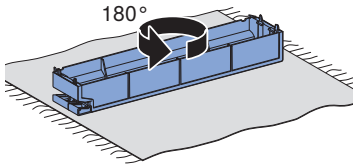

13

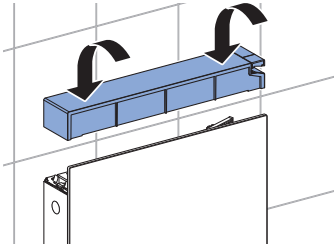

Geberit International AG
Schachenstrasse 77, CH-8645 Jona
documentation@geberit.com
www.geberit.com

