





13 801 811



- Ausladung 190 mm
- rechteckiger luftangereicherter Strahl
- Bohrungsdurchmesser 37 mm
- Anschluss 1/2"
- Durchfluss max. 23,8 l/min bei 3 bar Fließdruck

	Platin gebürstet	13 801 811-06
	Chrom	13 801 811-00
	Dark Chrome	13 801 811-19
	Messing gebürstet (23kt Gold)	13 801 811-28
	Bronze gebürstet	13 801 811-42
	Dark Platinum gebürstet	13 801 811-99

Empfohlenes Zubehör



- UP-Wandwinkel -** 35 085 970 90
- Min. Einbautiefe 90 mm
 - Max. Einbautiefe 163 mm

13 801 811

mm [inches]

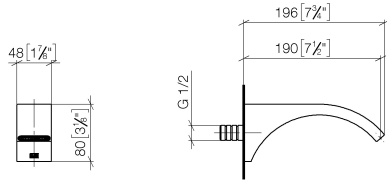

Durchflussdiagramm

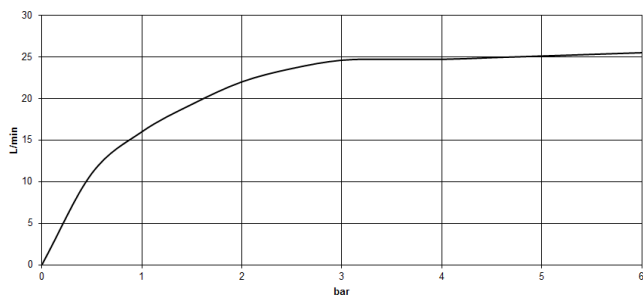

Codes & Standards

ASME A112.18.1

cUPC

DIN 4109

ISO 3822

Ü-Zeichen



CYO Wannenauslauf für Wandmontage - Platin gebürstet

CYO

13 801 811

Zertifikate

IAPMO_4976

LGA_38

13 801 811

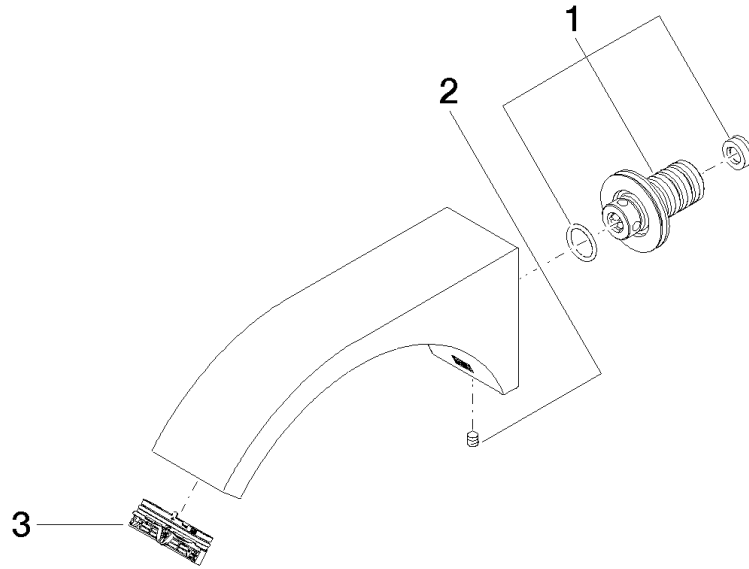

Ersatzteilstückliste

Nr.	Artikelnummer	Benennung	Verbaumenge	Lieferzeit
1	90 24 03 108 02 90	Nippel Set -	1,00	2
2	90 31 11 004 00 90	Befestigung -	1,00	2
3	90 29 03 121 00 90	Luftsprudler -	1,00	2