









90 18 20 025 00 Produktversion ab 01.04.2025



	Chrom	90 18 20 025 00-00
	chrom gebürstet (04)	90 18 20 025 00-04
	Platin gebürstet	90 18 20 025 00-06
	Platin	90 18 20 025 00-08
	Messing (23kt Gold)	90 18 20 025 00-09
	Weiß matt	90 18 20 025 00-10
	Dark Brass matt	90 18 20 025 00-16
	Dark Bronze matt	90 18 20 025 00-17
	Dark Chrome	90 18 20 025 00-19
	Light Gold gebürstet	90 18 20 025 00-27
	Messing gebürstet (23kt Gold)	90 18 20 025 00-28
	Schwarz matt	90 18 20 025 00-33
	Dark Brass gebürstet	90 18 20 025 00-39
	Bronze gebürstet	90 18 20 025 00-42
	Champagne gebürstet (22kt Gold)	90 18 20 025 00-46
	Champagne (22kt Gold)	90 18 20 025 00-47
	Chrom gebürstet	90 18 20 025 00-93
	Dark Platinum gebürstet	90 18 20 025 00-99



Umstellung 23 x 85 x 48 mm - Chrom

ERSATZTEILE

90 18 20 025 00 Produktversion ab 01.04.2025



Umstellung 23 x 85 x 48 mm - Chrom

ERSATZTEILE

90 18 20 025 00 Produktversion ab 01.04.2025

90 18 20 025 00 Produktversion ab 01.04.2025

Ersatzteile für die
anderen
Oberflächenvarianten
finden Sie hier:
chrom gebürstet (04)

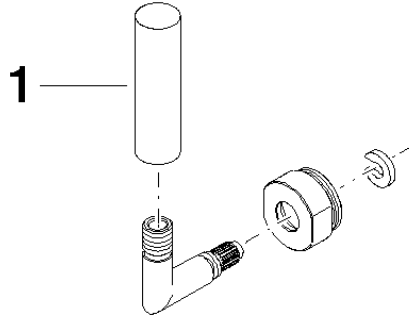

Ersatzteilstückliste

Nr.	Artikelnummer	Benennung	Verbaumenge	Lieferzeit
1	09 20 62 005-00	Griff Hebel Ø 15 x 55 mm - Chrom	1,00	10